

# Piesa T

## TCPL



### Descriere

Piesa tip T presata, prevazuta cu garnituri.

#### Cod comanda

Cod produs: **TCPL aaa bbb**

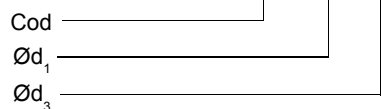

### Dimensiuni

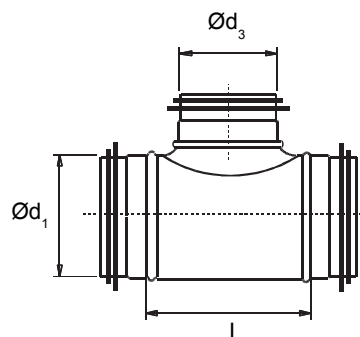

$\text{Ød}_1$ nom	$\text{Ød}_3$ nom	L	kg
100	100	150	0.45
125	100	185	0.50
	125	185	0.65
150	100	175	0.65
	125	215	0.75
	150	260	0.90
160	100	185	0.70
	125	230	0.80
	160	230	1.00
200	100	175	0.85
	125	215	0.95
	150	260	1.00
	160	270	1.10
250	100	175	1.00
	125	215	1.15

# Piesa T

# TCPL

## Date tehnice

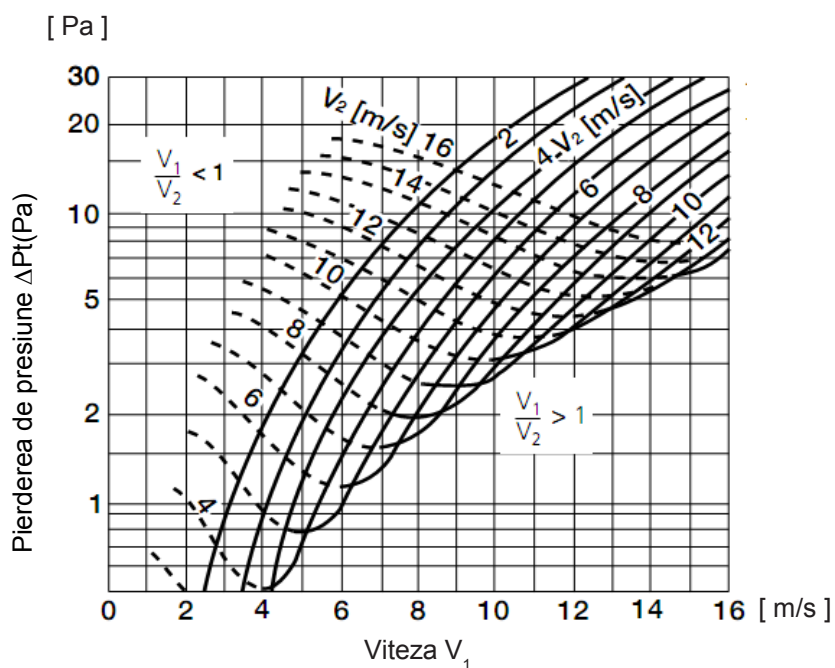
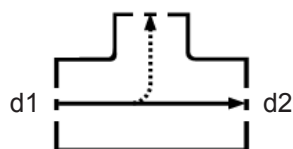
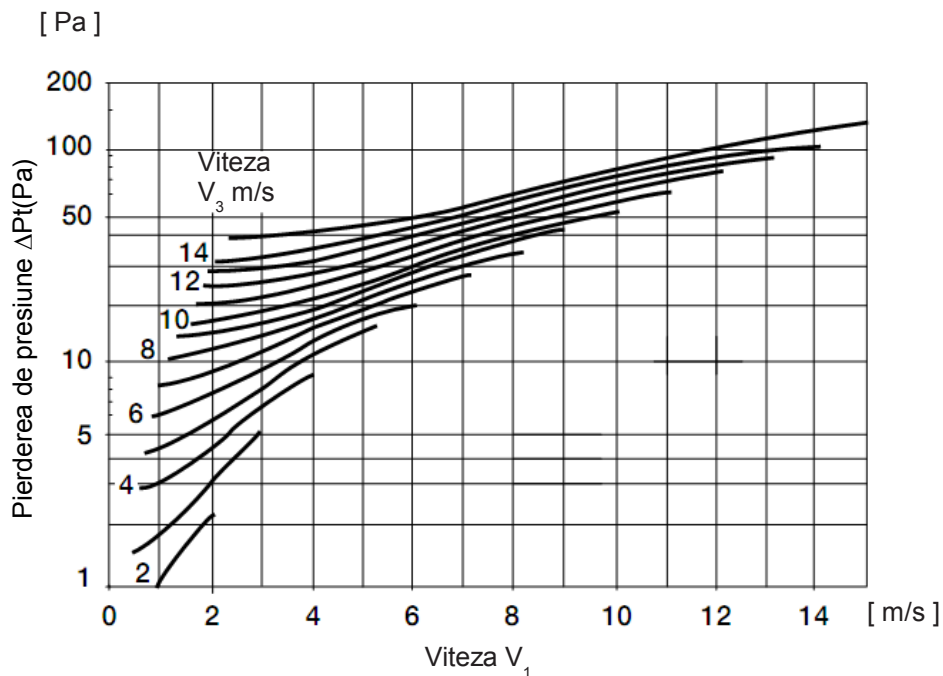
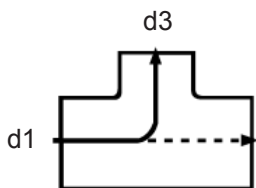

$V_1$  = viteza medie in d1  
 $V_2$  = viteza medie in d2  
 $V_3$  = viteza medie in d3

# Piesa T

# TCPL

## Date tehnice

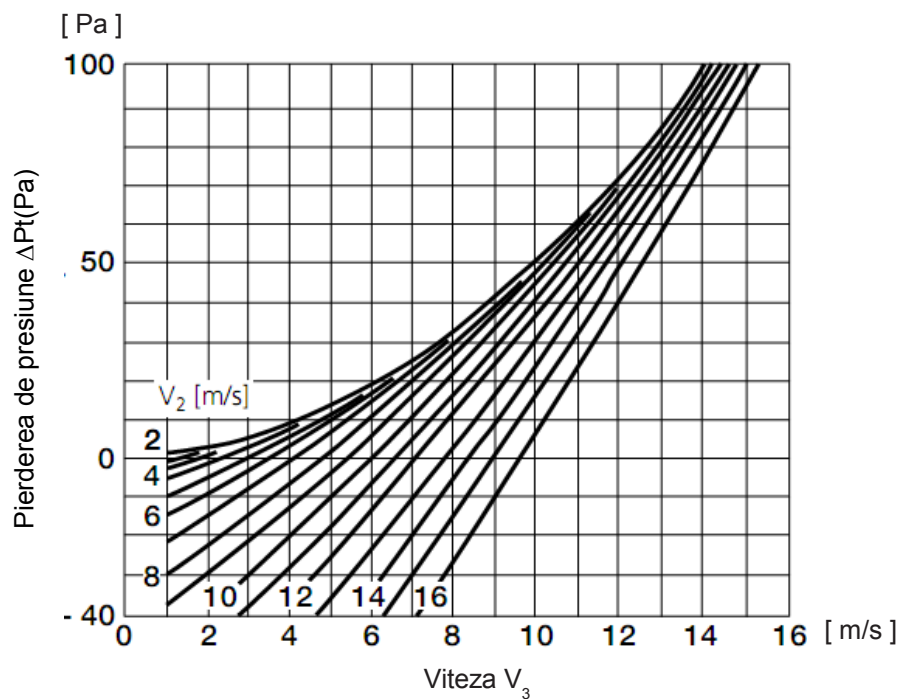
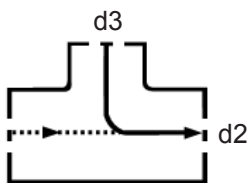
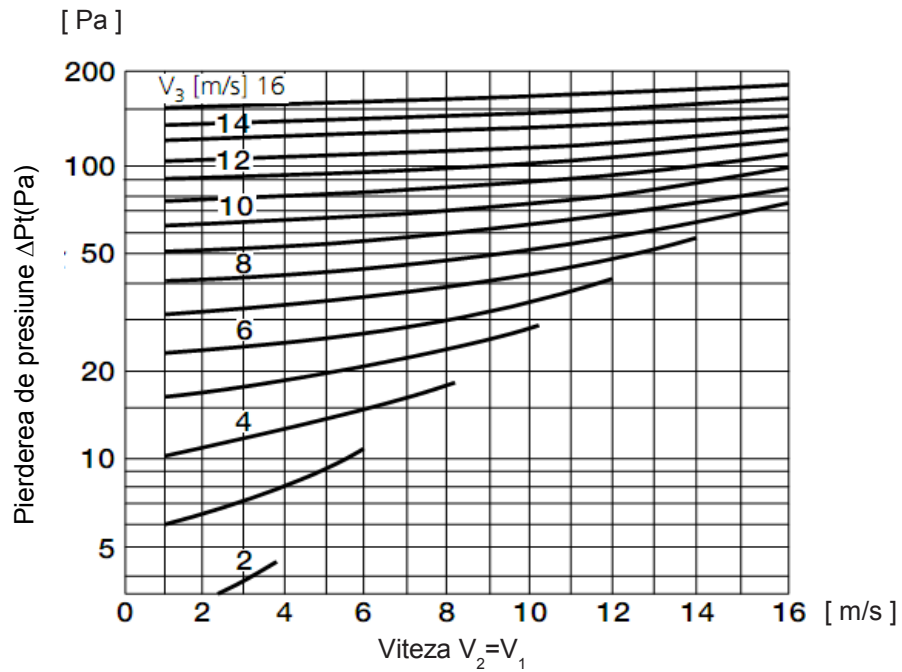
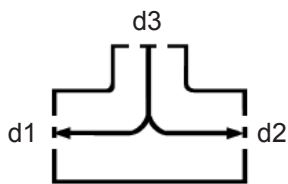

$V_1$  = viteza medie in d1  
 $V_2$  = viteza medie in d2  
 $V_3$  = viteza medie in d3

Piesa T

# TCPL

Date tehnice

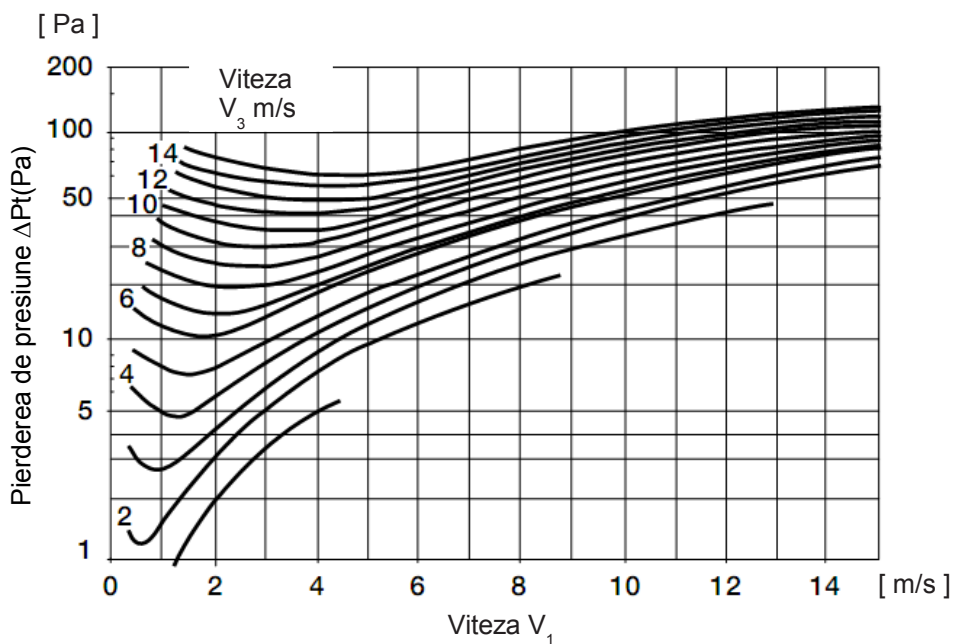
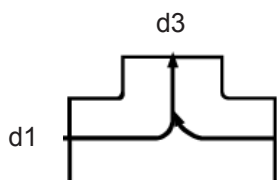
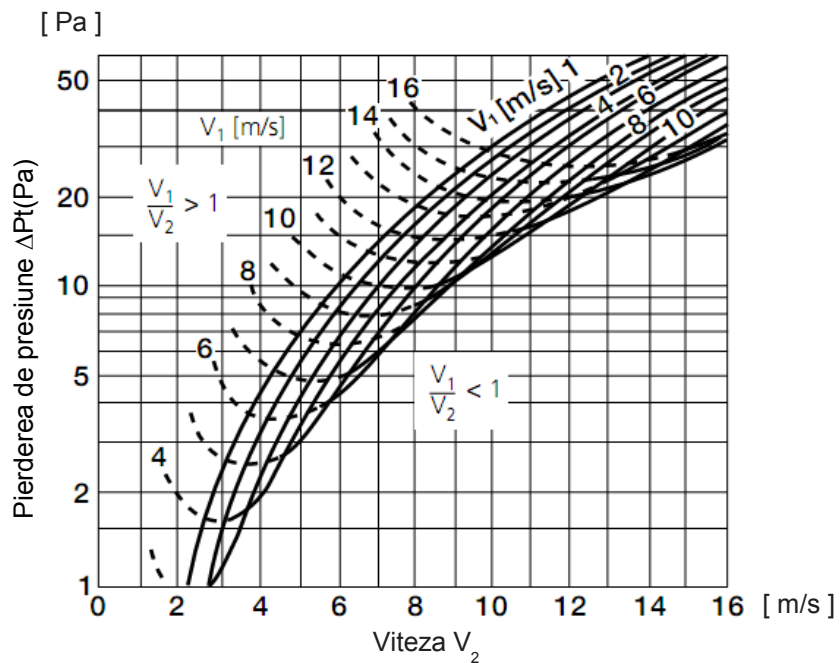
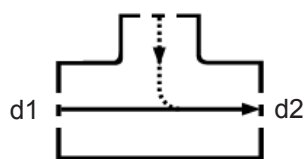

$V_1$  = viteza medie in d1  
 $V_2$  = viteza medie in d2  
 $V_3$  = viteza medie in d3